

# LAVATHERM 57520 electronic

Condenser Dryer

Operating Instructions



## Dear customer,

Please read these operating instructions through carefully, before using the appliance.

Please ensure you fully understand the safety instructions on the first pages of these operating instructions! Retain this instruction book for future reference, and pass on to any future owners.



The warning triangle and/or the key words (**Warning!**, **Caution!**, **Important!**), emphasize information which is important for your safety or the correct functioning of the appliance. It is essential that this information is observed.



This symbol guides you step by step when operating the appliance.



This symbol gives additional information and practical tips on using the appliance.



Tips and information about the economical and environmentally friendly use of the machine are marked with the clover symbol.

If you require assistance or advice on your appliance, please contact our Customer Care Department by letter or telephone:

Customer Care Department  
AEG Domestic Appliances  
55-77 High Street  
Slough  
Berkshire SL 1 1DZ  
Tel: 08705 350350

Printed on environmentally friendly paper ...  
Whoever thinks ecologically also acts ecologically.

# Content

<b>Important Safety Information</b> .....	5
<b>General Information</b> .....	7
<b>Disposal</b> .....	7
Packaging .....	7
Tumble Dryer .....	7
<b>Environmental protection tips</b> .....	8
<b>Description of the appliance</b> .....	10
Front view .....	10
Control panel .....	11
The programme selector positions .....	12
<b>Before using the appliance for the first time</b> .....	12
<b>Brief operating instructions</b> .....	13
<b>Drying</b> .....	14
Prepare the laundry .....	14
Open the door .....	14
Load the laundry .....	14
Closing the door .....	14
Select the drying programme .....	14
Start DELAY TIMER .....	15
Start the drying programme .....	16
Removing laundry or loading laundry when necessary .....	16
End of the drying process .....	16
Removing the laundry .....	16
Empty the water reservoir .....	17
Cleaning the door seal .....	17
Clean the fluff filter .....	18
Cleaning the heat exchanger .....	19
Switch-off the dryer .....	19
<b>Programme tables</b> .....	20
<b>A small glossary of textile information</b> .....	22
Care symbols .....	22

<b>Cleaning and maintenance</b> .....	23
Cleaning the filter area .....	23
Cleaning the drum .....	23
Cleaning the panel and operating parts .....	24
Cleaning the door seal .....	24
Cleaning the heat exchanger .....	24
<b>What to do if ...</b> .....	25
Replacing the interior light .....	27
<b>Service &amp; Spare Parts</b> .....	28
<b>Guarantee Conditions</b> .....	29
<b>For the installer - Safety information</b> .....	31
<b>Technical data</b> .....	32
<b>Electrical Connection</b> .....	33
<b>Door Reversal Instructions</b> .....	35
<b>Special accessories</b> .....	37
Drainage kit .....	37
Stacking kit .....	37
<b>Index</b> .....	39



## Important Safety Information

Your safety is of paramount importance, please ensure you read these warnings before installing or using the appliance. If you are unsure about any of the meanings of these warnings, contact the Customer Care Department.

### General Safety

- Any electrical work required to install this appliance should be carried out by a qualified electrician or competent person.
- Please follow the safety information in the installation section of this instruction book.
- This appliance is designed to dry normal domestic laundry. If the appliance is used for any other purpose or is incorrectly used, the manufacturer accepts no liability for any damages which may result.
- Switch off the appliance and isolate from the mains supply before carrying out any maintenance or cleaning work.
- Never operate the appliance if the mains cable is damaged or if the control panel, work top or base area are damaged allowing internal components to be accessible.
- Do not spray the tumble dryer with water.
- Do not dry textiles which have been treated with flammable cleaning agents and solvents.
- Clothes or articles of laundry which are dripping wet should not be placed in the dryer. Only load well-spun laundry.
- Laundry items containing sponge rubber or rubber-like materials must not be dried in the tumble dryer.
- If the drying cycle is interrupted, the laundry or drum may be hot.
- Do not use the tumble dryer without the bulb cover in position.
- Do not operate the appliance with a damaged filter or with no filter at all.
- Do not overload the appliance.
- When closing the door, please check that the washing is not caught in it.
- It is dangerous to alter the specifications or attempt to modify this product in any way.
- Adaptors and extension cables must not be used. There is risk of fire because of overheating!
- Do not use the mains cable to pull the plug out of the socket.

- If the appliance will be out of operation for an extended period of time, unplug it from the mains.
- Repairs to the appliance should only be carried out by qualified personnel. Repairs carried out by inexperienced persons may cause injury or serious malfunction. Contact your local AEG Service Force Centre for repair.
- Washing that is in poor condition (heavily worn) and items with loose fillings (cushions) that could break open must not be dried or aired. There is a risk of fire!
- Washing with rigid components (foot mats) will cover the air slots; the slots will also be covered if the drum is overfilled. Observe the maximum load of 5 kg. There is a risk of overheating which could cause a fire!
- Only dry washing that does not contain any explosive objects (fire lighters, spray cans). There is a risk of fire or an explosion!
- Clean the fluff filter after each drying procedure.
- Clean the heat exchanger regularly.
- In the case of washer / dryer tower combinations, do not place any objects on the dryer during use as they could drop down.

### **Child Safety**

- The appliance is designed to be operated by adults. Children should not be allowed to tamper with the controls or play with the appliance.
- Pets and children have been known to climb into tumble dryers. Please check the drum before use.
- Keep all packaging away from children.
- When disposing of the appliance, cut off the mains cable and destroy the plug. Disable the door catch to prevent young children being trapped inside.

### **Installation**

- Check the appliance for transportation damage before installation.
- Any electrical work required to install this appliance should be carried out by a qualified electrician or competent person.
- Do not install the appliance on deep pile carpet.
- Ensure the appliance is level.
- If the tumble dryer is installed next to a fuel burning stove, a heat insulation non-flammable pad must be inserted between the fuel burning stove and the tumble dryer; (dimensions 85 x 57.5 cm).

---

## General Information

- To prevent creasing do not exceed the maximum load stated in the programme table.
- When using fabric conditioning sheets, we recommend the conditioning sheet is pinned (using a safety pin) to an article of laundry and placed in the tumble dryer.
- Please ensure the appliance is easily accessible to an engineer after installation.

## Disposal

### Packaging

- Dispose of the packaging material correctly. All packaging materials are environmentally friendly and can be disposed of without any danger to the environment.
- The external plastic covering and bags inside are made of Polyethylen (marking >PE<).
- The padding is made of CFC free expanded polystyrene (marking >PS<).

### Tumble Dryer

When disposing of the tumble dryer.

- Cut off the mains cable and destroy the plug.
- Disable the door catch to prevent young children becoming trapped inside.
- Use an authorised disposal site.



## Environmental protection tips

- Your laundry will become light and soft in the laundry dryer even without a soft rinsing agent.
- Loosen your laundry before loading it into the dryer. This helps to prevent lengthy running times and creasing.
- Ensure your laundry is well spun.

In the following table we give an overview of specific electric consumption data depending on the spinning speed. This information is valid for 5kg laundry dried with the programme COTTONS STORAGE DRY:

Pre-drying:			Drying process:	
Revolutions per minute	Residual moisture		Required time in minutes	Power consumption in kWh
	in Litres	in %		
800	3.5	70	90	3.5
1000	3.0	59	85	3.0
1200	2.7	53	75	2.7
1400	2.5	50	70	2.6
1600	2.2	44	65	2.5

- Never obstruct the ventilation slits at the base of the dryer!
- Ensure that the room is well ventilated!
- Observe the maximum load instructions. Whenever possible, dry full loads.



- Choose the right drying programme for the type and quantity of laundry. The dryer will then operate as economically as possible. Some typical consumption values:

Drying programme	Fill weight in kg	Duration in Minutes	Power consumption in kWh
COTTONS STORAGE DRY <sup>1</sup>	5	90	3.5
COTTONS HAND IRON <sup>1</sup>	5	70	2.8
EASY CARES STORAGE DRY <sup>2</sup>	2.5	35	1.3

1) spun at 800 revolutions per minute

2) spun at 1000 revolutions per minute

If the amount of laundry is not enough for a particular degree of drying (e.g. HAND IRON), you should dry it in stages for best economy: Fill the dryer and select the programme HAND IRON; after the end of this programme take out your laundry for ironing. Finally dry the remaining laundry with the programme STORAGE DRY.

- Only use the SPECIAL CARE button for loads up to 2.5kg!
- Clean the fluff filter after every drying programme!
- Empty the water reservoir after every drying programme!



**Caution!** The condensed water is not suitable for drinking or for use with foodstuffs.

You can use the collected condensed water as distilled water in the household, but first pour it through a paper filter bag.

- Clean the heat exchanger regularly. The dryer will operate more economically if you clean the heat exchanger regularly.

# Description of the appliance

## Front view

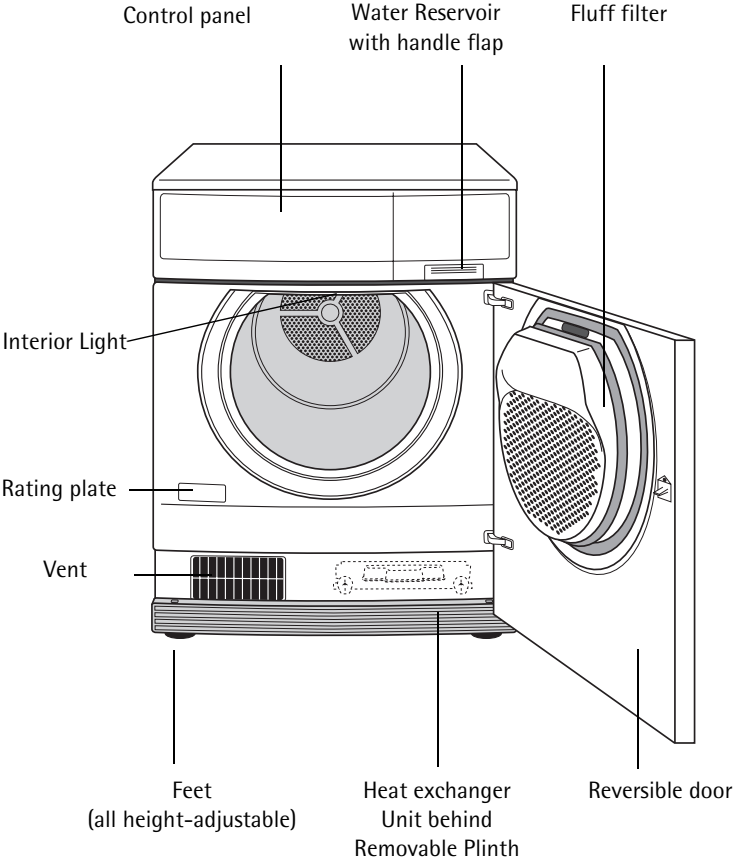

## Control panel

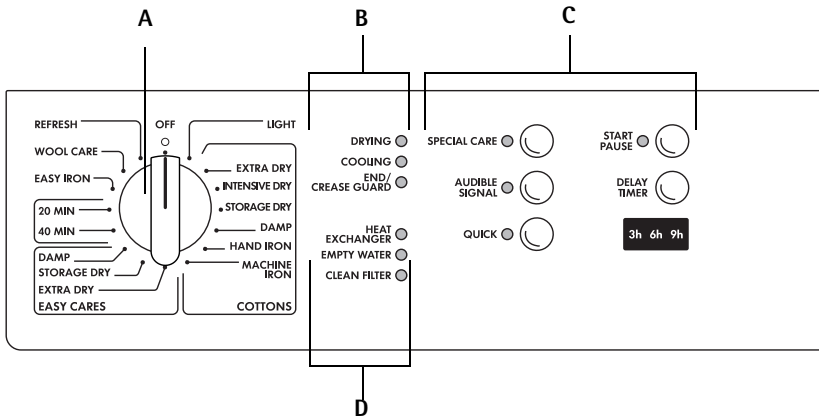

A Programme selector: To select the drying programme

B Programme run display: In each case the display for the current phase of the drying process is lit.

C Buttons and display block

- SPECIAL CARE button: For sensitive fabrics. This button has no effect if the QUICK button has already been pressed.
- AUDIBLE SIGNAL button: When switched-on, an audible signal is sounded at the end of the drying programme; then take-out the laundry
- QUICK button: reduces the drying time. Does not work with the programmes COTTONS DAMP, HAND IRON and MACHINE IRON or with the EASY CARES DAMP programme.  
If the SPECIAL CARE button has already been pressed, pressing the QUICK button has no effect.
- START/PAUSE button: To start or interrupt the programme.
- DELAY TIMER button: to pre-set the delay start time within a range of 0, 3, 6 and 9 hours; delay is shown in display panel
- Display: displays the hours until the drying programme begins.

D Instructions for the user:

- HEAT EXCHANGER: Clean the heat exchanger!
- EMPTY WATER: Empty the condensate container!
- CLEAN FILTER display: Clean the fluff filter!

## The programme selector positions

- **OFF:**  
The tumble dryer is switched off.
- **LIGHT:**  
The drum light switches on when the door is opened.
- **Programme group COTTONS:**  
Programmes for drying cotton and linen fabrics;  
maximum load 5 kg.
- **Programme group EASY CARES:**  
Programmes for drying mixed fabrics and synthetics;  
maximum load 2.5 kg.
- **Time Programmes:**  
For additional drying or for drying loads of less than 1 kg.
- **EASY IRON programme:**  
Special drying programme with anti-crease mechanism for easy-care fabrics;  
maximum load 1 kg.
- **WOOL CARE programme:**  
To freshen up woollen fabrics after they have been line dried;  
maximum load 1 kg.
- **REFRESH programme**  
For optimum results when refreshing items of clothing and gently cleaning textiles with the aid of commercially available dry-cleaning products (please follow the manufacturer's instructions for use);  
Programme duration: 35 minutes;  
maximum load 1 kg.

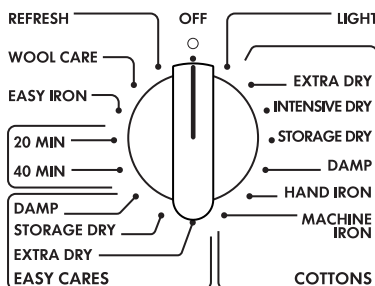

## Before using the appliance for the first time

- ☞ Wipe out the drum using a damp cloth or else insert damp cloths and carry out a short drying procedure (20 mins.).

## Brief operating instructions

- Ensure the laundry is well spun before tumble drying.
- Prepare the laundry.
- Open the door and load the laundry.
- Shut the door.  
Attention! Do not catch washing in the door.
- Select the drying programme on the programme selector.
- Press the SPECIAL CARE, AUDIBLE SIGNAL or QUICK button if required
- Set the DELAY TIMER if required.
- Start the programme by pressing the START/PAUSE-button.

While the programme is running you can open the door to take-out laundry or add more laundry.

At the end of the programme (END / CREASE GUARD display is illuminated, acoustic signal is heard, if set, the anti-crease phase begins):

- Remove the laundry.
- Empty the water reservoir.
- Clean the fluff filter.

If the indicator HEAT EXCHANGER is highlighted:

- It is essential to clean the heat exchanger!
- Switch-off the dryer by turning the programme selector to the OFF position.

# Drying

## Prepare the laundry

- To prevent tangled bundles of laundry: Close zip fasteners; button-up bed linen and pillow cases; tie-together loose tapes, e.g. aprons.
- Empty all pockets.
- Remove all metal objects (i.e. paper clips, pins, etc.).
- Turn clothing consisting of double-layer fabric inside out (such as cotton-lined anoraks with the cotton layer facing outwards). The fabrics will dry better.
- Loosen the laundry.

## Open the door

To open the door:

- Press firmly against the door (Press position ).

## Load the laundry

- Load the prepared laundry into the dryer.

## Closing the door

Closing the door:

- apply pressure to the door until it clicks audibly into place.





**Caution!** Ensure the laundry does not get caught in the door when the door is closed! This could damage the laundry!

## Select the drying programme

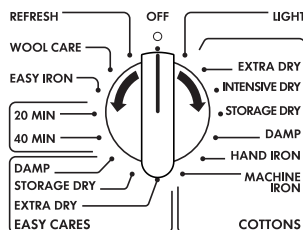

Select the suitable drying programme using the programme selector (see "Programme tables").



 If required, select the buttons SPECIAL CARE, AUDIBLE SIGNAL or QUICK.

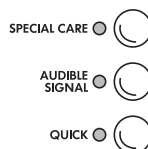

- **SPECIAL CARE button**  
This programme operates with reduced heat. Press the SPECIAL CARE button for fabrics bearing the care symbol . Gentle drying is advisable for heat-sensitive fabrics (such as acrylic and viscose).  
The SPECIAL CARE button has no effect if the QUICK button has already been pressed.
- **AUDIBLE SIGNAL button**  
During the crease-protection phase (immediately after the drying phase), an acoustic signal is sounded at intervals (see "End of drying process").
- **QUICK button**  
The selected programme runs with shortened programme duration for the same degree of drying.  
The QUICK button does not work with the programmes COTTONS DAMP, HAND IRON and MACHINE IRON or with the EASY CARES DAMP programme.  
The QUICK button has no effect if the SPECIAL CARE button has already been pressed.

## Start DELAY TIMER

With the DELAY TIMER function you can delay the start of the drying programme by 3, 6 or 9 hours.

 Setting the programme.

 Hold down the DELAY TIMER button until the required number of hours before the programme is to start is shown in the display panel.

 Press START/PAUSE button.

After the set number of hours has elapsed the tumble dryer will automatically begin the set drying programme. The number of hours until the set drying programme is due to begin is shown in the display panel.

You can adjust the pre-selected delay start at any time.



## Start the drying programme

 Press the START button.

The drying programme starts. The programme progress is indicated on programme phase display.

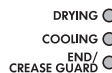



## Removing laundry or loading laundry when necessary

You can interrupt the drying process at any time to remove some of the laundry or to add more laundry.

 Open the door.

 **Caution!** The laundry and the drum may be hot.

 Remove or add more laundry.

 Close the door.

 Press the START button to resume the drying process.

## End of the drying process

The **cooling phase** starts shortly before the end of the drying process: The heater is switched-off during this phase.

After the cooling phase the END / CREASE GUARD display is illuminated. You can now remove the washing from the tumble dryer.

The **crease guard phase** follows automatically after the drying process. The drum rotates intermittently. This keeps your laundry loose and crease-free.

If you have pressed the AUDIBLE SIGNAL button, an acoustic signal is sounded intermittently during this phase.

You should remove the washing at the latest towards the end of the anti-crease phase to avoid creasing.

## Removing the laundry

 Open the door and remove the laundry.



## Empty the water reservoir



**Caution!** The condensed water is not suitable for drinking or for use with foodstuffs.

The water reservoir should be emptied after every drying programme. This avoids interruption of a programme when the water reservoir is full.



Grasp the handle flap of the water reservoir and pull-out completely.

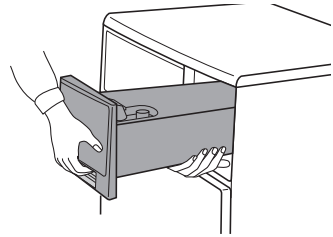

Push the cover of the water reservoir to the side and pour-out the condensed water.

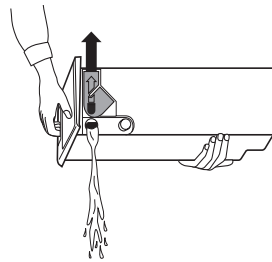

Re-insert the water reservoir into the control panel.

If the drying cycle has not yet ended:



Press the **START / PAUSE** button to continue the drying cycle.



The water reservoir has a capacity of approx. 3.8 litres. This is sufficient for a laundry load of 5 kg which has been machine spun at 800 revolutions per minute.

## Cleaning the door seal



Rub the door seal with a damp cloth.

## Clean the fluff filter

To ensure efficient operation of the tumble dryer, clean the fluff filter after each drying programme.

Also check whether there are any remnants or fluff from the washing in the drum; remove immediately.

- ✎ Press the catch of the filter lid downwards.

The filter lid will open.

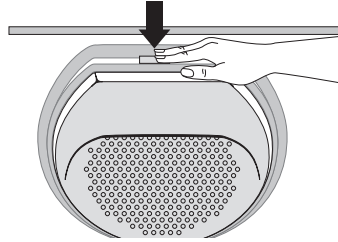

- ✎ Take-out the fluff filter.

- ✎ Remove fluff out of the fluff filter, with a moistened hand.

- ✎ Re-insert the fluff filter.

- ✎ Press against the filter lid until it catches into the locking device.

- i** The filter lid cannot catch shut without the fluff filter in place and the door cannot be closed.

- !** **Warning!** The dryer must not be operated with a damaged or blocked fluff filter.

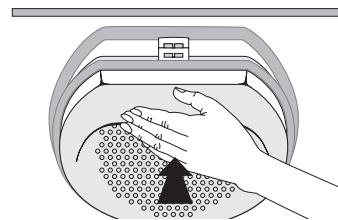
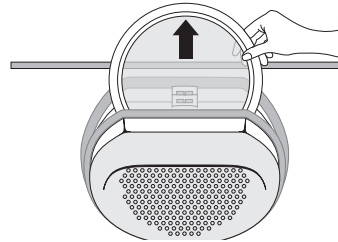

## Cleaning the heat exchanger

**!** **Important!** When the HEAT EXCHANGER display lights, it is essential to clean the heat exchanger. Otherwise your dryer might suffer damage. In addition energy consumption will be increased if the heat exchanger unit is covered with fluff.

**☞** Open the door.

**☞** Press on the two tabs to unlatch and take off the removable plinth.

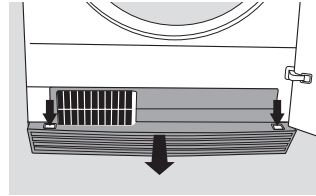

**☞** Turn the two securing disks through a quarter turn each outwards.

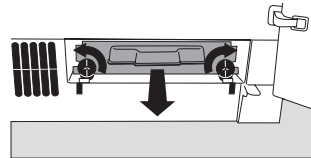

**☞** Pull the heat exchanger out of the base by the handle.

**☞** Clean the heat exchanger, best with a hand-held brush or by rinsing with a hand-held shower head. The water removal slits on the rear of the heat exchanger must be free too.

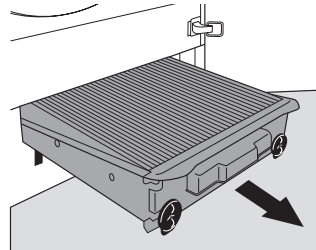

**!** **Important!** Do not use any sharply pointed objects to clean the heat exchanger. They could make it leak.

**☞** Reinsert and push in and turn each one of the two securing disks through a quarter turn inwards. The words "top – oben – en haut" must be at the top.

**☞** Re-mount the plinth.



**!** **Important!** The dryer must not be operated without heat exchanger.

## Switch-off the dryer

**☞** Turn the programme selector to the OFF position.



# Programme tables

## Programme group COTTONS

care symbols , ; maximum load 5 kg

Programme	Laundry Type	Examples for
EXTRA DRY	Heavy weight or multi-layered fabrics	Towelling material, bath robes
INTENSIVE DRY	Thick textiles that are to be thoroughly dried.	Towelling, terry towels
STORAGE DRY	Fabrics of medium weight, articles not made up of multi-layers	Towel laundry, hand towels
DAMP	Lightweight materials requiring ironing	Cotton shirt and underwear
HAND IRON	Normal cotton and linen articles	Sheets and pillowcases, tablecloths
MACHINE IRON	Cotton and linen articles, to be ironed by rotary ironer or starched laundry	Cotton sheets and pillowcases, tablecloths

## Programme group EASY CARES

care symbols , <sup>1</sup>, ; maximum load 2.5kg

Programme	Laundry Type	Examples for
EXTRA DRY	Heavy weight or multi-layered fabrics	Sweatshirts, bed linen and table linen
STORAGE DRY	Lightweight materials which do not require ironing	Easycare fabric shirts, table linen, baby clothes, socks and underwear
DAMP	Lightweight synthetics and cotton/polyester mixtures requiring ironing	Bed and table linen, easycare fabric shirts and blouses

1) Press the SPECIAL CARE button!

**Time programmes****care symbols  <sup>1</sup>, ; loads less than 1 kg**

You can select 20 and 40 minutes programme duration for additional drying of individual pieces of laundry or to dry small quantities.

1) Press the SPECIAL CARE button!

**EASY IRON programme****care symbols  <sup>1</sup>, ; maximum load 1 kg (approx. 5-6 shirts)**

For drying fabrics such as shirts and blouses; minimal ironing required.

Result depends on type and finish of fabric.

Recommendation: spin fabrics in the washing machine at a speed of about 1200 revolutions and then transfer immediately to the dryer. Remove fabrics immediately after drying and hang on a hanger.

1) Press the SPECIAL CARE button!

**WOOL CARE programme****maximum load 1 kg**

To freshen up the wool fibres of woollen garments after they have been line dried, worn or stored for longer periods they can be treated briefly using warm air. The wool emerges beautifully soft.

Recommendation: remove fabrics immediately after drying.

**REFRESH programme****maximum load 1 kg**





For optimum results when refreshing items of clothing and gently cleaning textiles with the aid of commercially available dry-cleaning products (please follow the manufacturer's instructions for use);

Programme duration: 35 minutes.

# A small glossary of textile information

## Care symbols

Ensure articles to be dried are suitable for tumble drying. If they are one of the following symbols should be present on the care label:

-  Normal drying
-  Drying with special care (press the SPECIAL CARE button!)
-  This fabric can be tumble dried. The fabric manufacturer does not stipulate if the piece of laundry should be dried on a normal or gentle programme.
-  Do not tumble dry

### **If you do not find any of these care symbols:**







Dry whites and coloureds as well as mixed fabrics at normal temperature. Press the SPECIAL CARE button if you are drying delicate fabrics.

- Wool  
Do not dry any woollen items in the dryer.  
As a follow-up treatment for woollen fabrics in quantities up to 1 kg select the WOOL CARE programme.
- Fabrics sensitive to temperatures  
Dry fabrics sensitive to temperatures (such as acrylic or viscose) and textiles with the care label  with the SPECIAL CARE button selected.
- Cotton jersey and hosiery have a tendency to shrink! Do not dry these fabrics excessively.
- New coloured textiles  
To avoid the possibility of dye transference do not dry new coloured textiles together with light-coloured laundry.

# Cleaning and maintenance

## Cleaning the filter area

 **Important!** When the CLEAN FILTER display lights, it is essential to clean the fluff filter. Otherwise your dryer might suffer damage. A small amount of fluff may reach the area around the filter in spite of the fluff filter. Therefore you should clean the entire filter area from time to time, or at least every three months.

-  Remove the fluff filter.
-  Hold the filter lid by the top and pull it forwards until it is released from both holders.
-  Remove the fluff from the entire filter area – preferably with a vacuum cleaner.
-  Press both pins of the filter lid into the holders on the door until they click in.
-  Reinsert the fluff filter.
-  Press against the filter lid until it clicks into the lock.

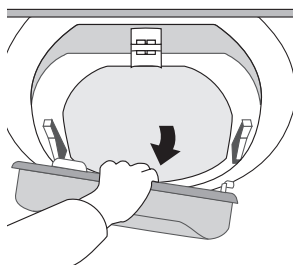

## Cleaning the drum

 **Warning!** Do not clean the stainless steel drum with abrasive detergents or steel wool!

Fabric softeners or lime in the water can cause a scarcely visible deposit to form on the drum. The dryer is then no longer reliably able to recognise how dry the washing is. When the washing is removed from the dryer it will be damper than you expect.

-  Wipe the inside of the drum and the drum fins with white vinegar to avoid any residues/deposits effecting the sensors. This is particularly important if you regularly use fabric conditioning sheets or dry starched items in the dryer.

## Cleaning the panel and operating parts



**Warning!** Do not use household furniture polish or aggressive detergents.



Wipe over the panel and operating parts with a damp cloth. Only use warm water.

## Cleaning the door seal



Rub the door seal with a damp cloth immediately after the drying procedure.

## Cleaning the heat exchanger



**Important!** When the HEAT EXCHANGER display lights, it is essential to clean the heat exchanger. Otherwise your dryer might suffer damage. In addition energy consumption will be increased if the heat exchanger unit is covered with fluff.

See the section "Drying, cleaning the heat exchanger".



## What to do if ...

If the tumble dryer is not working correctly please carry out the following checks before calling out an engineer.

Symptom	Possible cause	Solution
The tumble dryer will not start	The appliance is not plugged in	Plug in the appliance
	The fuse has blown	Check the fuse
	The START/PAUSE button has not been pressed	Press the START/PAUSE button
	No programme has been selected	Select the required programme
	The door is not properly closed	Close the door
	The water reservoir is full	Empty the water reservoir
The results are unsatisfactory	The wrong programme has been selected	Select a different programme
	Fluff filter blocked	Clean the fluff filter
	heat exchanger unit covered with fluff	Clean the heat exchanger unit
	The tumble dryer has been overloaded	Observe the maximum loads stated for each programme
	Laundry not sufficiently spun prior to tumble drying	Ensure the wash load is well spun before tumble drying
	The vent in the base of the appliance is covered	Ensure the vent is clear
	A residue may have formed on the drum interior, blocking the sensors	Clean the inside of the drum with white vinegar

Symptom	Possible cause	Solution
The drum illumination does not work	Is the tumble dryer plugged in	Plug in the tumble dryer
	The programme selector is in the OFF position	Turn the programme selector dial to LIGHT
	The bulb needs replacing	Replace bulb
The door cannot be closed	Fluff filter has not been inserted correctly and/or the filter lid not closed	Replace the fluff filter and ensure the filter lid is closed
Display EMPTY WATER is lit	Condensation container full	Empty the condensation container
EMPTY WATER indicator illuminated, even though the container has already been emptied	Foreign bodies, e. g. animal hairs, can block the inlet nozzle as well as the valve on the end of the EMPTY WATER container	With the container pulled out, switch on the appliance momentarily. The blockage can be removed from the container shaft or the hair cleaned out of the valve
The dryer terminates the drying process automatically: END is displayed shortly after programme start	Too dry or too little laundry in the drum for the selected programme	Select time programme or higher drying stage (e.g. EXTRA DRY instead of INTENSIVE DRY)
The drying process takes unusually long. Note: The drying cycle ends automatically after 3 hours: - DRYING and COOLING indicators are flashing - acoustic signal sounds	The heat exchanger unit is covered with fluff	Clean the heat exchanger unit
	Fluff filter is clogged	Clean the fluff filter
	SPECIAL CARE button pressed and too much laundry is in the drum	Check the programme selection: SPECIAL CARE button appropriate only for laundry amounts up to 2.5kg
	Too much laundry is in the drum	Reduce the amount of laundry in the drum
	Laundry too damp	Pre-dry (spin) the laundry more thoroughly

If after these checks, the tumble dryer still does not work, contact your local AEG Service Force Centre.

Please note that it will be necessary to provide proof of purchase for any in-guarantee service calls.

In-guarantee customers should ensure that the above checks have been made as the engineer will make a charge if the fault is not a mechanical or electrical breakdown.

## Replacing the interior light

 A replacement bulb can be purchased through your local AEG Service Force Centre (Part No: 899647072580/6).

 **Warning!** Never use standard light bulbs in your Lavatherm.

 Isolate the appliance from the mains supply.

 Screw-off the bulb cover. (The bulb is located at the top behind the door; see *Front view*).

 Replace the defective bulb.

 Screw-on the bulb cover.

 **Warning!** For safety reasons the bulb cover must be screwed-on. The dryer must not be operated, without the cover in place.

# Service & Spare Parts

In the event of your appliance requiring service, or if you wish to purchase spare parts, please contact Service Force by telephoning:

**08705 929 929**

Your telephone call will be automatically routed to the Service Force Centre covering your post code area.

For the address of your local Service Force Centre and further information about Service Force, please visit the website at [www.serviceforce.co.uk](http://www.serviceforce.co.uk)

Before calling out an engineer, please ensure you have read the details under the heading „What to do if ...“

When you contact the Service Force Centre you will need to give the following details:

1. Your name, address and post code.
2. Your telephone number
3. Clear and concise details of the fault.
4. The model (PNC) and serial number (S no.) of the appliance (found on the rating plate).

PNC no. ....

S no. ....

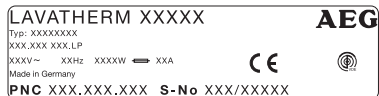

5. The purchase date

Please note that a valid purchase receipt or guarantee documentation is required for in-guarantee service calls.

## Customer Care

For general enquiries concerning your AEG appliance or for further information on AEG products please contact our Customer Care Department by letter or telephone at the address below or visit our website at [www.aeg.co.uk](http://www.aeg.co.uk).

Customer Care Department  
AEG Domestic Appliances  
55-77 High Street  
Slough  
Berkshire, SL1 1DZ  
Tel. 08705 350350 (\*)

(\*) Calls may be recorded for training purposes

---

# Guarantee Conditions

## **Standard guarantee conditions**

We, AEG, undertake that if within 12 months of the date of the purchase this AEG appliance or any part thereof is proved to be defective by reason only of faulty workmanship or materials, we will, at our discretion repair or replace the same FREE OF CHARGE for labour, materials or carriage on condition that:

- The appliance has been correctly installed and used only on the electricity or gas supply stated on the rating plate.
- The appliance has been used for normal domestic purposes only, and in accordance with the manufacturer's operating and maintenance instructions.
- The appliance has not been serviced, maintained, repaired, taken apart or tampered with by any person not authorised by us.
- All service work under this guarantee must be undertaken by a Service Force Centre. Any appliance or defective part replaced shall become the Company's property.
- This guarantee is in addition to your statutory and other legal rights.
- Home visits are made between 8.30am and 5.30pm Monday to Friday. Visits may be available outside these hours in which case a premium will be charged.

## **Exclusions**

This guarantee does not cover:

- Damage or calls resulting from transportation, improper use or neglect, the replacement of any light bulbs or removable parts of glass or plastic.
- Costs incurred for calls to put right an appliance which is improperly installed or calls to appliances outside the United Kingdom.
- Appliances found to be in use within a commercial environment, plus those which are subject to rental agreements.
- Products of AEG manufacture which are not marketed by AEG.

## European Guarantee

If you should move to another country within Europe then your guarantee moves with you to your new home subject to the following qualifications:

- The guarantee starts from the date you first purchased your product.
- The guarantee is for the same period and to the same extent for labour and parts as exist in the new country of use for this brand or range of products.
- This guarantee relates to you and cannot be transferred to another user.
- Your new home is within the European Community (EC) or European Free Trade Area.
- The product is installed and used in accordance with our instructions and is only used domestically, i. e. a normal household.
- The product is installed taking into account regulations in your new country.

Before you move please contact your nearest Customer Care Centre, listed below, to give them details of your new home. They will then ensure that the local Service Organisation is aware of your move and able to look after you and your appliances.

France	Senlis	+33 (0) 44 62 29 29
Germany	Nürnberg	+49 (0) 800 234 7378
Italy	Pordenone	+39 (0) 800 117511
Sweden	Stockholm	+46 (0) 8 672 5360
UK	Slough	+44 (0) 1753 219899

---

## For the installer – Safety information

- Check the appliance for transportation damage before installation.
- If the tumble dryer has to be carried, first remove the plinth!
- Any electrical work required to install this appliance should be carried out by a qualified electrician or competent person.
- Do not install the appliance on deep pile carpet.
- If the tumble dryer is installed next to a fuel burning stove, a heat insulation non-flammable pad must be inserted between the fuel burning stove and the tumble dryer: (dimensions 85 x 57 cm).
- If the dryer is installed in a room with a fuel burning heating appliance, consult your local Corgi registered installer.
- The tumble dryer should not be installed in situations which may be subject to freezing temperatures.
- The installation site must be well ventilated.
- Ensure the appliance does not stand on the electrical supply cable.
- If the machine is situated on carpeted floor, please adjust the feet in order to allow air to circulate freely.
- The tumble dryer must be level.
- Observe the safety precautions in the operating instructions for your dryer.

## Technical data

Height x Width x Depth	85x60x60cm
Depth with the door open	117cm
Height adjustable from	1.0/-0.4cm
Empty weight	approx. 46kg
Load (depending on the programme)	max. 5kg
Power consumption in acc. with IEC 1121 s.e. (5 kg Cotton, spun at 800 revolutions per minute, programme COTTONS STORAGE DRY)	3.5kWh
Area of use	Household
Permissible ambient temperature	+5°C up to +35°C

- CE** This appliance complies with the following EC directives:
- 73/23/EEC of 19/2/1973 'Low voltage directive'
  - 89/336/EEC of 3/5/1989 'EMC directive' including the Modification directive 92/31/EEC



# Electrical Connection

Any electrical work required to install this appliance should be carried out by a qualified electrician or competent person.



## WARNING - THIS APPLIANCE MUST BE EARTHED.

The manufacturer declines any liability should these safety measures not be observed.

Before switching on, make sure the electricity supply voltage is the same as that indicated on the appliance rating plate. The rating plate is located inside the door.

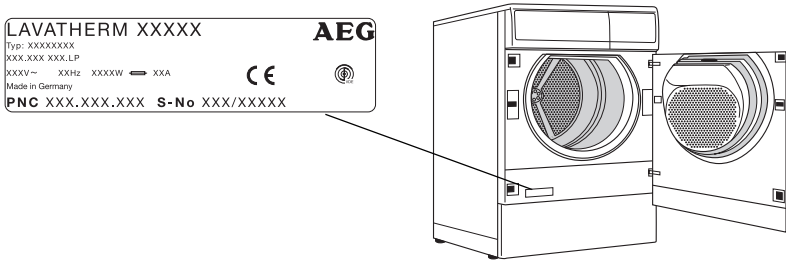

The appliance is supplied with a 13amp plug fitted. In the event of having to change the fuse in the plug supplied, a 13amp ASTA approved (BS 1362) fuse must be used.

Should the plug need to be replaced for any reason. The wires in the mains lead are coloured in accordance with the following code:

Green and Yellow : Earth  
Blue : Neutral  
Brown : Live

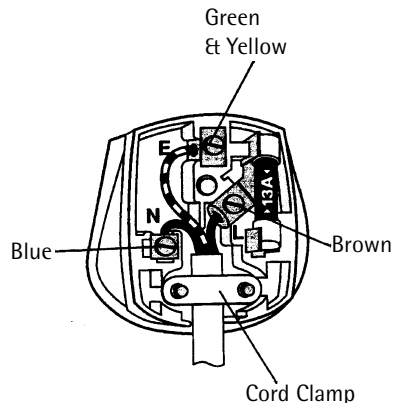

- The wire coloured green and yellow must be connected to the terminal marked with the letter "E" or by the earth symbol  or coloured green and yellow
- The wire coloured blue must be connected to the terminal "N" or coloured black.
- The wire coloured brown must be connected to the terminal marked "L" or coloured red.
- Upon completion there must not be cut, or stray strands of wire present and the cord clamp must be secure over the outer sheath.



**WARNING: A cut off plug inserted into a 13 amp socket is a serious safety (shock) hazard. Ensure that the cut off plug is disposed of safely.**

## Permanent connection

In the case of a permanent connection it is necessary that you install a double pole switch between the appliance and the electricity supply (mains), with a minimum gap of 3 mm between the switch contacts and of a type suitable for the required load in compliance with the current electrical regulations.

The switch must not break the yellow and green earth cable at any point.

## Positioning

To ensure correct operation:

- The appliance must be level. Use a spirit level if necessary and adjust the feet to compensate for any unevenness in the floor.
- The surrounding area must be kept clean, free of dust and fluff.
- Do not install the appliance where the temperature may fall below freezing or rise above 35 °C.
- Do not install the appliance on deep pile carpets or obstruct the front ventilation grille, as this will affect the air circulation and could lead to a build-up of heat which would adversely affect the operation of the machine.

# Door Reversal Instructions







The door opening direction can be changed if required.

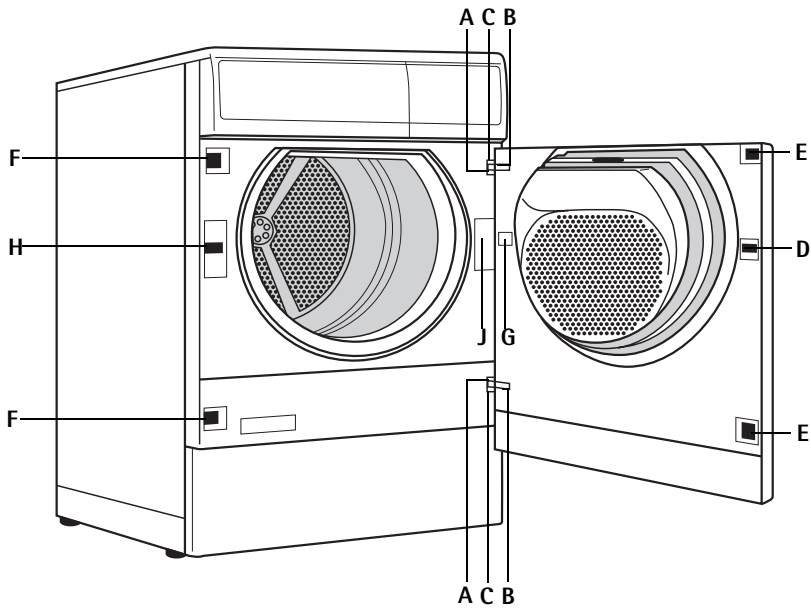





**Warning!** Before reversing the door, isolate the appliance from the mains supply.

Proceed as follows to reverse the door opening direction:



-  Unscrew the screws A on the front panel of the appliance.
-  Take-off the door by sliding it out horizontally.
-  Unscrew the screws B on the inside of the door and take-off the hinges C.
-  Unscrew and take-off the locking block D.
-  Release the coverplates E, F and G with a thin screwdriver by pressing on the latching device, releasing them on one side. Take them out and insert them on the opposite side.
-  Screw-on the hinges C and the locking block D on the opposite side of the door.
-  Unscrew the door catch H, take it out and pull-off the plug.

-  Take-out the latched catch covering J and pull-off the plug.
  -  Connect the door catch H and the catch covering J on the respective opposite side to the plug, insert into the hole and screw-down or latch into position.
  -  Push the door with the hinges into the holes provided for them in the front panel of the appliance and firmly attach it with the screws.
-  **Warning!** The appliance is safe again for operation only when all plastic parts have been mounted.

---

## Special accessories

You can obtain the following special accessories from your retailer.

### Drainage kit

A drainage kit (TRZ955, E-No. 916 019 000) can be purchased to adapt the dryer to drain the condensed water into an existing drain, sink etc. This eliminates having to empty the condensed water reservoir, although the reservoir must still be inserted into the control panel of the machine.

### Stacking kit

With these kits you can combine your laundry dryer with any LAVAMAT automatic washing machine to a washing and drying column. The appliances are stacked in space-economising manner in this arrangement, the washing machine at the bottom and the laundry dryer at the top.

The following two kits are available:

- |                          |                   |
|--------------------------|-------------------|
| - without shelf (TRZ981) | E-No. 916 018 900 |
| - with shelf (TRZ901)    | E-No. 916 018 901 |



# Index

## A

Acrylate .....	15
Acrylic .....	22
Anorak .....	14
AUDIBLE SIGNAL .....	15, 16

## C

Closing the door .....	18
Condenser .....	24
Connection .....	33
Control panel .....	11
Cool-down phase .....	16
Crease protection phase .....	16

## D

DELAY TIMER .....	15
Door .....	35

## E

EASY IRON .....	12, 21
Easy-care fabrics .....	22

## F

Fabric softeners .....	23
Filter area .....	23
Fluff filter .....	18
Front view .....	10
Furniture polish .....	24

## G

Glossary .....	22
Guarantee .....	29, 30

## H

Heat exchanger .....	19, 24
----------------------	--------

## I

Installation .....	6, 31
Interior light .....	27
Ironing .....	9

## L

Lime .....	23
------------	----

## O

Opening the door .....	14
------------------------	----

## P

Packaging .....	7
-----------------	---

## Q

QUICK .....	15
-------------	----

## R

Rating plate .....	28
REFRESH .....	12, 21

## S

Safety Information .....	5
SPECIAL CARE .....	15
START .....	16

## T

Two-layer fabric .....	14
------------------------	----

## U

Use condensate .....	9
----------------------	---

## V

Viscose .....	22
---------------	----

## W

Water reservoir .....	17
Wool .....	22
WOOL CARE .....	12, 21

 **From the Electrolux Group. The world's No. 1 choice.**

*The Electrolux Group is the world's largest producer of powered appliances for kitchen, cleaning and outdoor use. More than 55 million Electrolux Group products (such as refrigerators, cookers, washing machines, vacuum cleaners, chain saws and lawn mowers) are sold each year to a value of approx. USD 14 billion in more than 150 countries around the world.*

AEG Hausgeräte GmbH  
Postfach 1036  
D-90327 Nürnberg

<http://www.aeg.hausgeraete.de>

© Copyright by AEG

822 944 226-00- 0103/PRO

Subject to change without notice